



# Joint Base San Antonio 502d Air Base Wing



Brig Gen Len Patrick  
Commander  
502 ABW



January 2010



# Overview



- What is Joint Basing?
- Joint Base San Antonio Scope
- Structure
- Services Provided
- Milestones



# What is Joint Basing?



**Now**



AF Installation Management

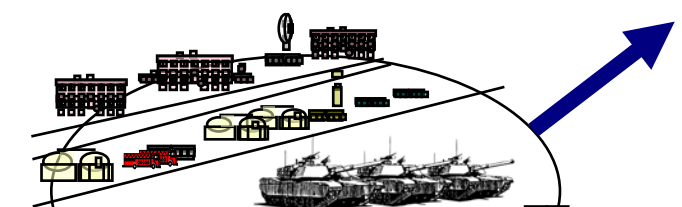

Army Installation Management

**Joint Basing (JB)**

1. Policy
2. Standards & Metrics



**Future**



**IM delivered by the lead Military Dept**

**JB is a BRAC mandate to consolidate installation support functions at adjacent & nearby installations under one Military Department to optimize installation management**



# Joint Base Locations



Navy Lead

- 1. Joint Base (JB) Pearl Harbor - Hickam, HI (Phase II)
- 2. Navy Base Guam / Andersen, GU (Phase I)
- 3. JB Anacostia - Bolling, DC (Phase II)
- 4. Naval Station Norfolk / Ft Story, VA (Phase I)

Army Lead

- 5. JB Ft Lewis - McChord, WA (Phase II)
- 6. JB Ft Myer - Henderson Hall, VA (Phase I)

AF Lead

- 7. Charleston / Naval WS Charleston, SC (Phase II)
- 8. JB McGuire - Ft Dix - Naval AS Lakehurst, NJ (Phase I)
- 9. JB Andrews - Naval Air Facility Wash, MD (Phase I)
- 10. JB Elmendorf - Richardson, AK (Phase II)
- 11. Lackland / Randolph / Ft Sam, TX (Phase II)
- 12. Langley / Ft Eustis, VA (Phase II)

**Lead Component responsible for providing Installation Support for the entire Joint Base**













# JBSA Supported Units







## Lackland (80)

- Air Force Intelligence, Surveillance & Reconnaissance Agency ★★
- 59<sup>th</sup> Medical Wing ★★
- 24<sup>th</sup> Air Force ★★
- 433d Airlift Wing ★
- 37<sup>th</sup> Training Wing 
- AF Information Operations Center 
- Defense Language Institute 
- Inter-American AF Academy 
- 149<sup>th</sup> Fighter Wing 
- National Security Agency / Central Security Service TX 
- 70 additional units

## Randolph (35)

- Air Education & Training Command ★★★★★
- 19<sup>th</sup> Air Force ★★
- AF Personnel Center ★★
- AF Recruiting Svc ★
- 12<sup>th</sup> Flying Training Wing 
- 30 additional units

## Fort Sam Houston (96)

- USARNORTH Fifth US Army ★★★★★
- Installation Management Command ★★★★★
- Army Medical Command ★★★★★
- USARSOUTH Sixth US Army ★★
- Army Medical Dept Center & School ★★
- Medical Education Training Campus ★★
- Great Plains Medical Regional Command ★★
- Brooke Army Medical Center ★
- Dental Command & Veterinary Command 
- Medical Information Technology Center 
- Institute of Surgical Research 
- Intrepid National Armed Forces Rehabilitation Center 
- 84 additional units

**211 Supported Units**  
**27 General Officers**  
**16 SES's**





# Customer Focused Structure

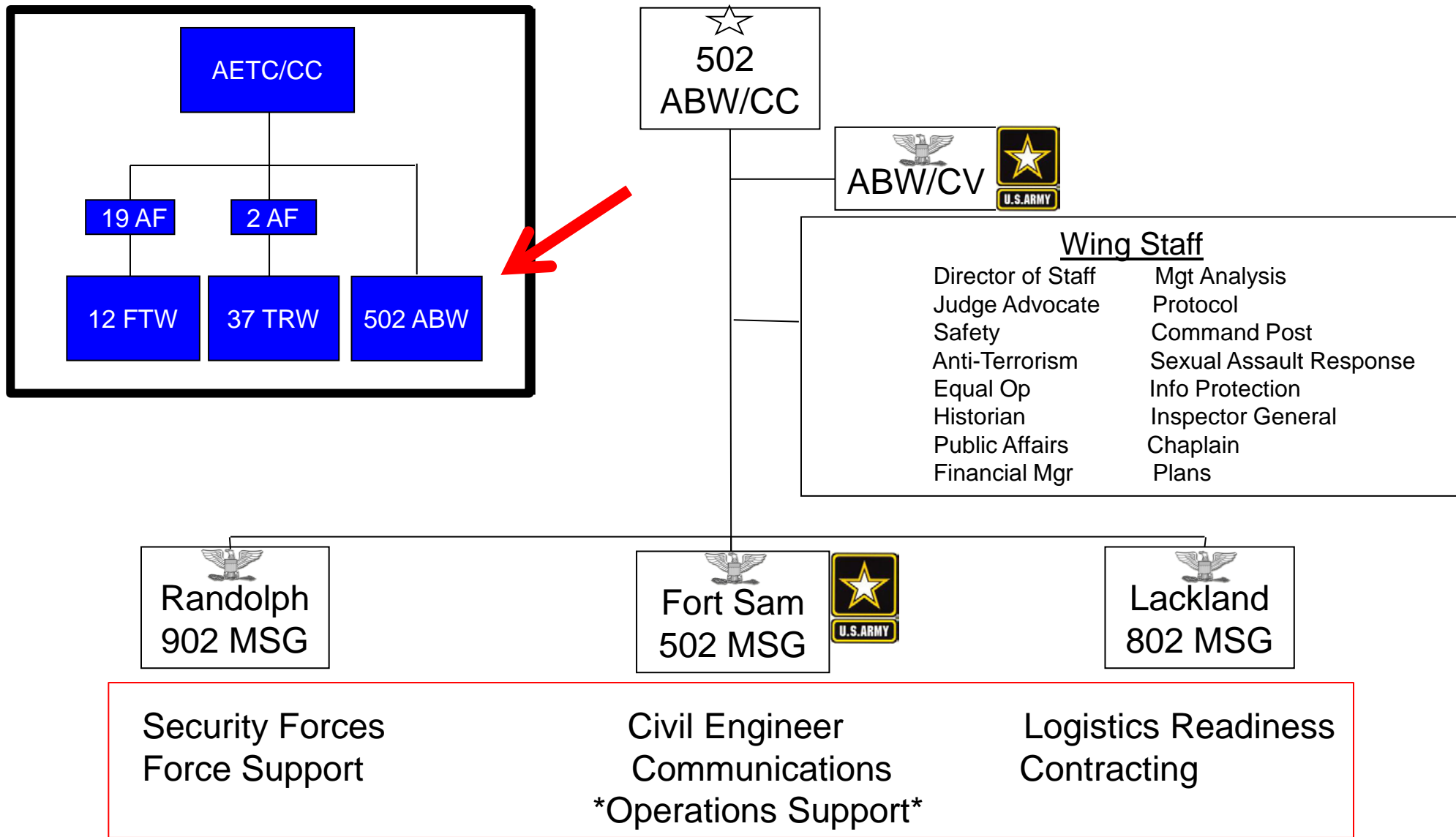

**Total Personnel: ~ 8,000**  
**502 ABW/CC direct report to AETC/CC**



# SA Real Property Mgmt Agency (SARPMA)



## Background

- SARPMA Established 1977-1978, activated 1989
- Forced upon the AF by General Accounting Office (GAO) because they believed that centralized management was more efficient
- Mission: “to provide economical, efficient and effective Civil/Facilities Engineering support for the needs specified by the SARPMA Charter”
- Included Brooks, Lackland, Randolph AFB, Fort Sam Houston, Camp Bullis and Wiley, Segov Auxiliary, San Antonio AFS, 22 Army Res centers, and the Randolph and Fort Sam Houston facilities at Canyon Lake.

## Lessons Learned

- Be responsive to customers – SARPMA caused damage to its reputation in early years
- Set expectations – SARPMA did not meet predicted savings, which was the sole reason for creating the org in the beginning
- Perception matters – Installation Commanders believed that SARPMA did not respond adequately to their needs
- Continue to evolve with time – Need an atmosphere of flexibility & enthusiasm



# Services Provided



- Command Support
- Community Services
- Environmental Services
- Facilities
- Fire and Emergency Services
- Housing
- Human Resources
- Information Technology
- Logistics
- Operational Mission Services
- Security Services





# Key Milestones



- ABW Stand Up – 31 Jul 09
- MOA Signed by VCSAF/VCSA – 14 Nov 09
- IOC – 31 Jan 10
- FOC – 1 Oct 10

- Phase I IOC – 5 Phase I Installations
- Phase I FOC –
- Phase II IOC - 7 Phase II Installations
- Phase II FOC -

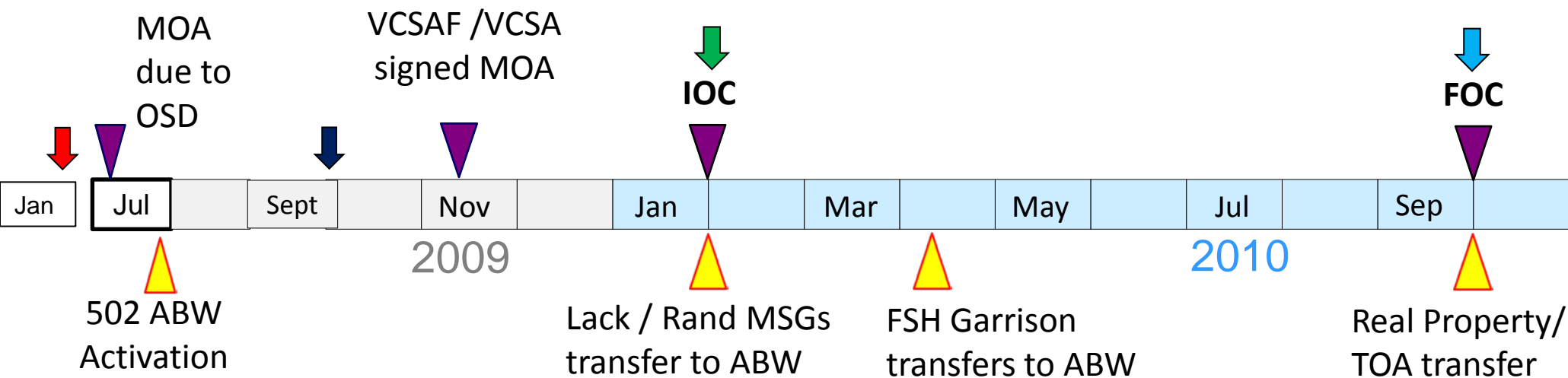



# Joint Base San Antonio

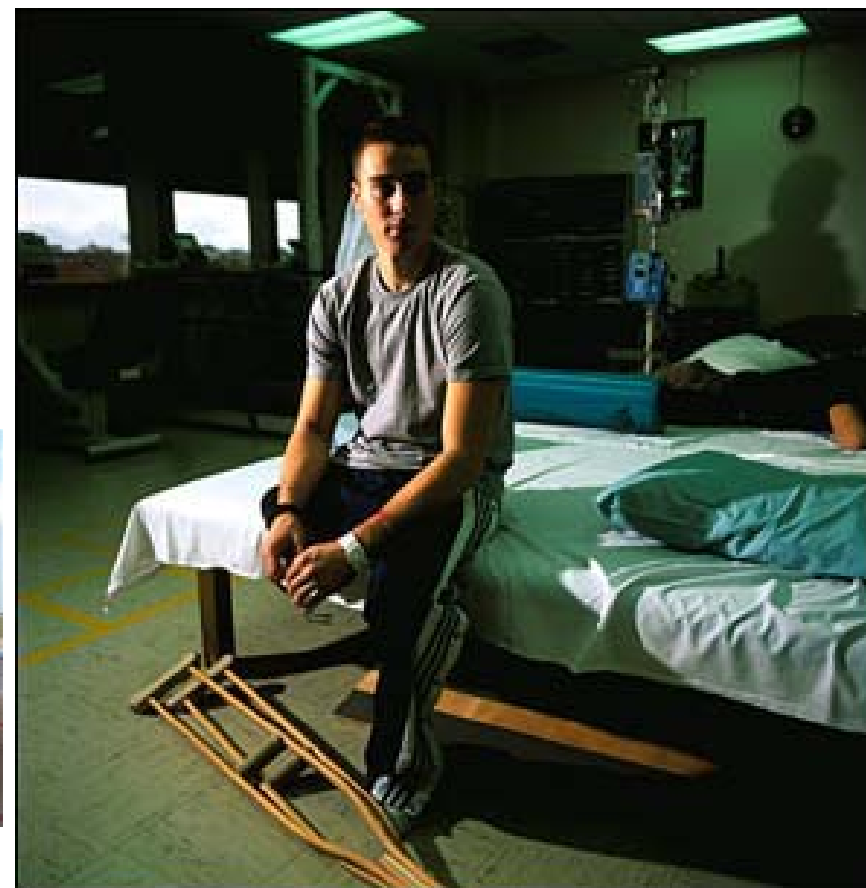

*Training and taking care of Service members and their families.*

## Questions?